

Helix Miniature High Pressure Pump

Up to 100 PSI (6.9 bar)

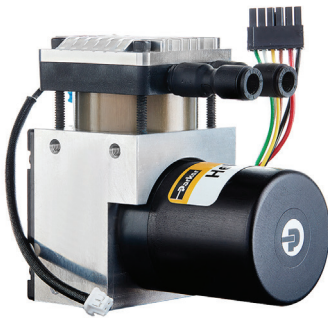

The Helix is a compact, high pressure pump designed to enable the smallest of point-of-care instruments. Helix enables high pressure operation in challenging high altitude environments and applications where external compressed air is not available. Delivering more than 5.5 LPM flow and pressure up to 100 PSI (6.9 bar), the Helix pump provides the best solution for bench-top diagnostic devices where performance is critical and space is limited.

Markets

- Point-of-Care Testing
- Molecular Diagnostics
- Nucleic Acid Purification
- Genomics

Applications

- Air Over Liquid
- Pneumatic Actuation
- Microfluidic Chips

Features

- Integrated unloading X-Valve enables high pressure restarts
- Internal flywheel for low speed operation at high pressure
- Oil free piston
- Simple mounting features
- Fast fluid connections with push-in fittings
- RoHS and REACH compliant 

Product Specifications

Physical Properties

Operating Environment¹ :
41 to 113°F (5 to 45°C)
Storage Environment :
-22 to 158°F (-30 to 70°C)
Humidity:
Up to 80% Relative Humidity Non-condensing
Wetted Materials:
PPS, FKM, EPDM, PTFE Aluminum, 316 Stainless Steel <i>The Helix pump is not sealed and not designed to pump gases that cannot escape to the environment</i>
Weight:
Helix pump with Unloading Valve: 20.3 oz (576 g)

Pneumatic

Maximum Unrestricted Flow:
Up to 5.5 LPM @ 3000 RPM
Pressure Range:
Pressure Only Operation Continuous Duty: 60 PSIG (4.1 Barg) <i>Operating @1400 RPM (1.5 Vdc Control)</i>
Intermittent Duty: Up to 100 PSIG (6.9 Barg)
Pneumatic Connections:
6mm Male Ports for Push-in Fittings
Unloading Valve:
Valve Type: 2-Way NO X-Valve Continuous Duty: 100 PSIG (6.9 Barg) Voltage: 24 VDC Power: 1 Watt

Electrical

Motor Type (DC):
Brushless DC Motor
Nominal Motor Voltages:
24 VDC <i>Other voltages available upon request</i>
Electrical Termination:
4.4 inch (110mm) Wire Length Connector: Molex 43645-0400 Pin 1: Tachometer Speed (Green) Pin 2: 0-5VDC Input (White) Pin 3: + VDC Power (Red) Pin 4: -Ground (Black)
Electrical Termination:
12 inch (305mm) Wire Length



ENGINEERING YOUR SUCCESS.

Typical Flow Curve

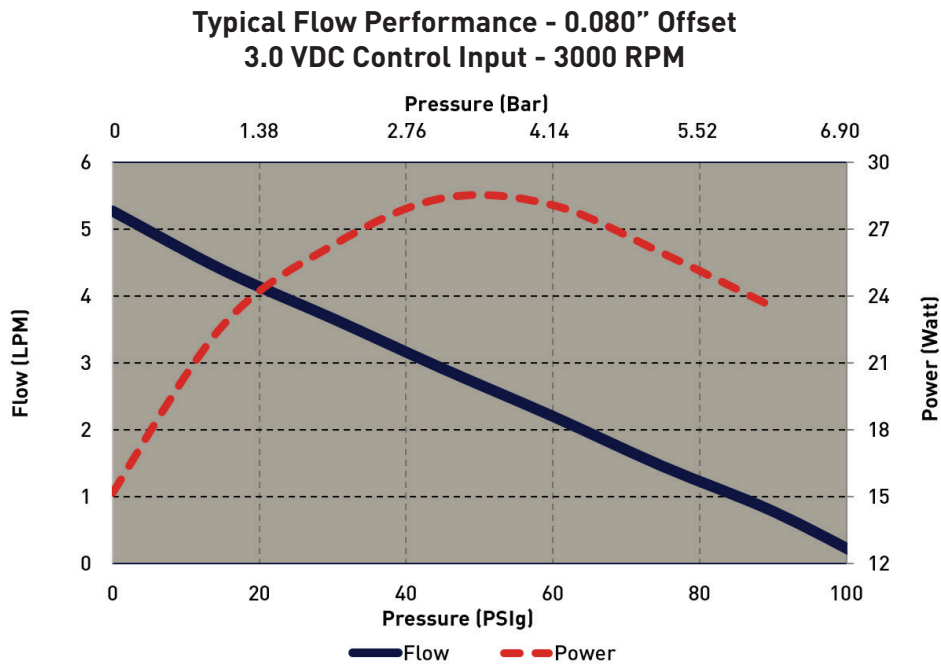
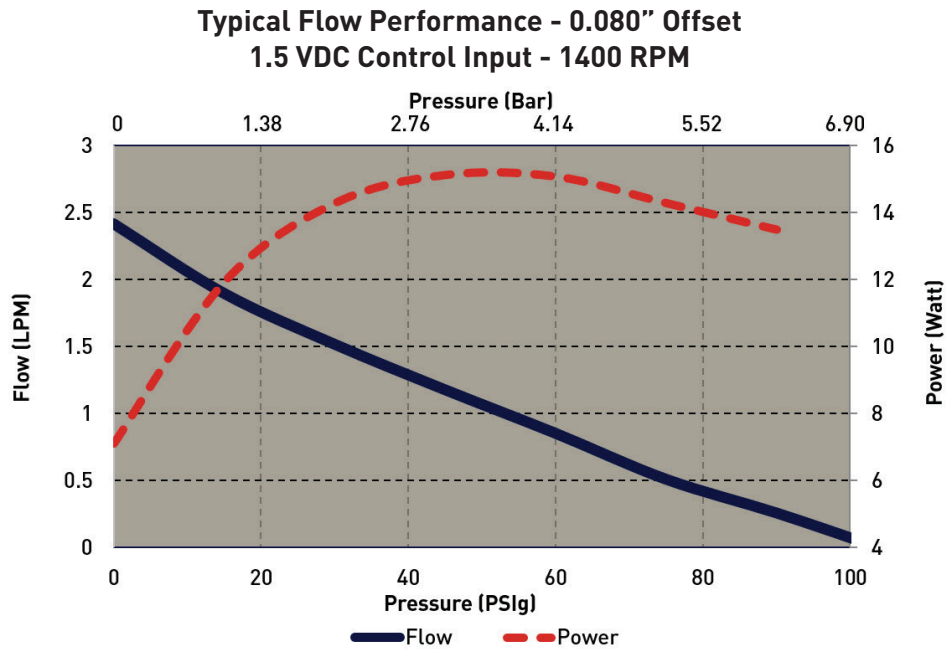

- Curves show flow capability with 0.080" pump offset.
- With a 5.0 Vdc control input the pump will operate at approximately 4400 RPM and up to 8.5 LPM, but not recommended for continuous operation.

Mounting Guidelines

- Mounting holes are provided on both sides of the pump body. The 6x mounting holes are tapped for M4x0.7 machine screws, with a maximum depth of 0.4 inches [10.2 mm]

Pneumatic Port Connections

- The Helix pump has 2 straight 6mm ports designed to connect with 6mm push-in-fittings
- Parker has a 6mm to 6mm push-in fitting available as an accessory. The port is designed to work with most industry standard push-in adapters.
- Tubing rated for >100 PSIG (6.9 barg) is recommended.

Mechanical Drawings

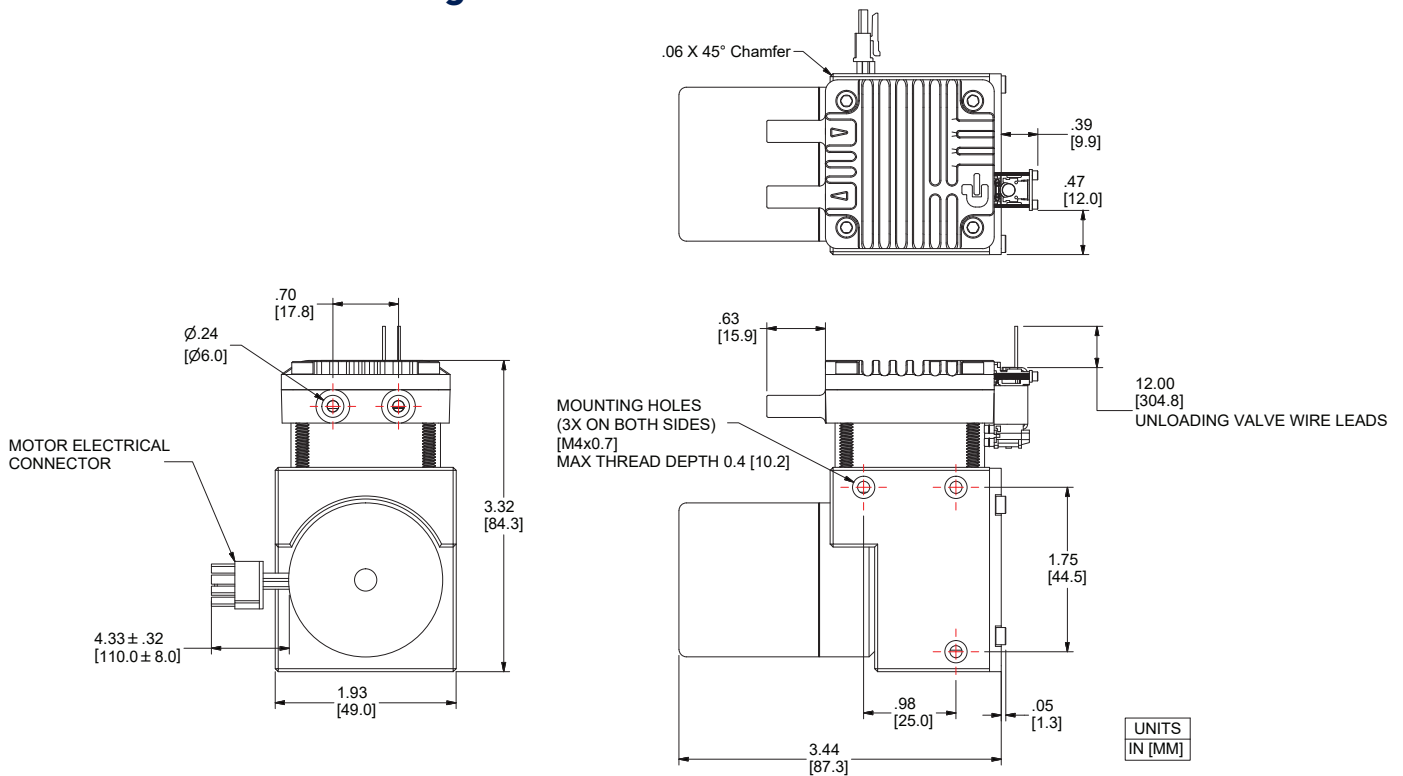

Electrical Integration and Motor Control

Motor Electrical Connection

Intregrated Electrical Connector	Manufacturer: Molex Housing Part Number: 43645-0400 Terminal Part Number: 43030-0002
Termination	Pin 1: Tachometer (Green) Pin 2: 0-5VDC Input (White) Pin 3: + VDC Power (Red) Pin 4: -Ground (Black)  <i>Pin 1 - Connector - Mate side</i>
Wire Specification	UL AWM Style 1006 +VDC and Ground: 20 AWG 0-5VDC Input and Tachometer: 24 AWG

Motor Supply Power Electrical Details

Supply Voltage Range	10-28 VDC
Internal Protection Current Limit	2.3 Amp

0-5VDC Control Electrical Details

On Board Motor Circuit	0-5VDC input See circuit details below If the input is disconnected (floating input) the pump will not operate.
User Control Circuit	User must supply 0 to 5 VDC analog signal for control

Tachometer Electrical Details

Speed Signal Output	0-5VDC square wave 18 Pulses per rotation of the pump
On Board Motor Circuit	See circuit details below Low signal will be <0.5VDC, High will be >4.0VDC

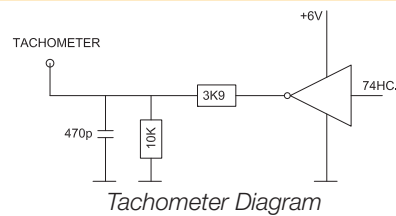
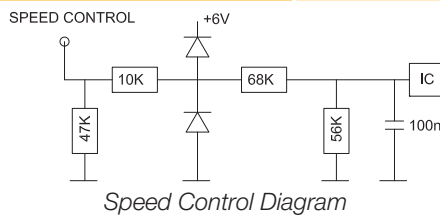

Unloading Valve Electrical Connection

Termination	Stripped and Tinned Non-Polarized
Wire Specification	UL AWM Style 1007 26 AWG, 7 Strand

Unloading Valve Supply Power Electrical Details

Supply Voltage Range	24 VDC ±10%
Coil Resistance	549 Ohms ±5%

Other Motor Control Considerations

The drive electronics for the BLDC motors are integrated into the motor itself, all that is needed is a power supply with the sufficient voltage and current.

Typical Flow Diagram

Point of Care Test System (POCT)

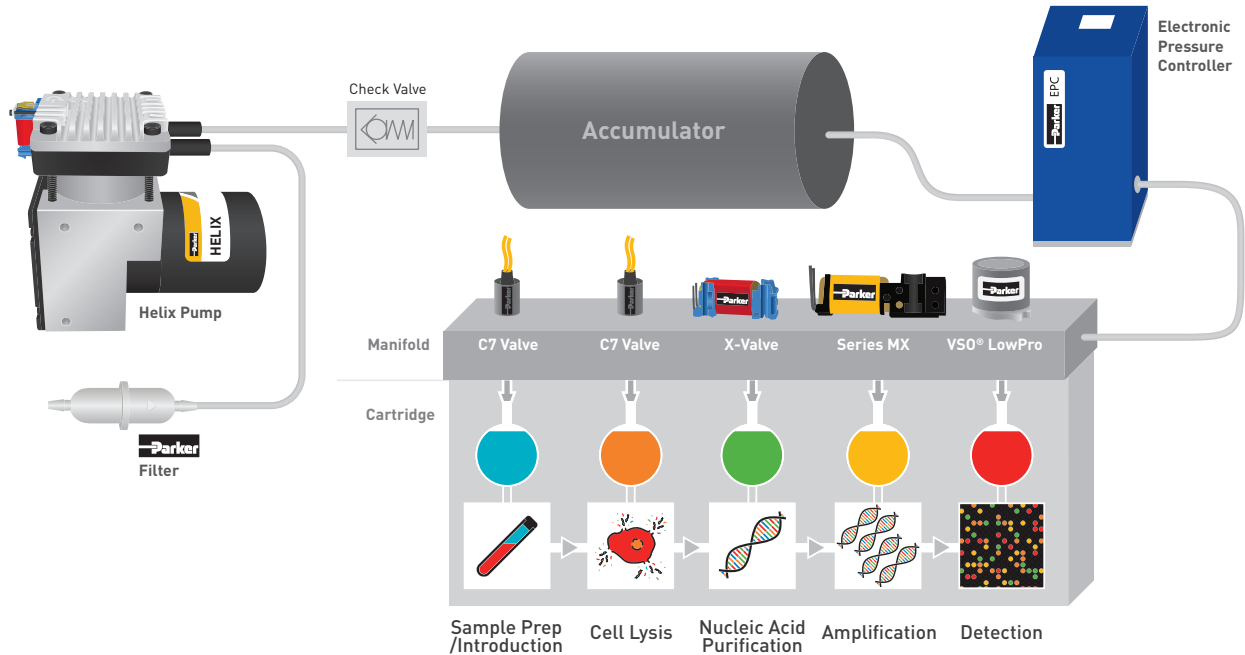

Application Notes

Unloading Valve:

A common application for the Helix is intermittently recharging a pressure accumulator in a compact system. The integrated unloading X-Valve removes pressure from the pump head, allowing the pump to restart against system pressures as high as 100 PSIG (6.9 Barg).

When operating the pump to pressurize the accumulator, the valve should be powered to close the valve. When the charge pressure has been achieved and the pump turned off, the solenoid valve power should be removed, so the normally-open valve will vent the pump internal pressure to atmosphere.

It is recommended to use a check-valve between the outlet and accumulator to hold pressure in the system (the Helix pump is not designed to be leak-tight).

Pump Schematic with Unloading X-Valve:

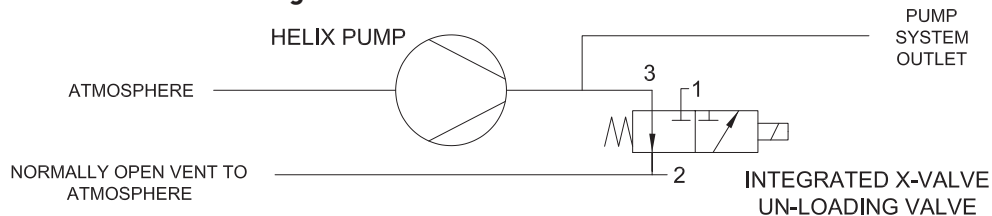

Operating Conditions

When operating at high pressure (>60 PSIG [4.14 barg]) and high speed (>1500 RPM) the Helix pump may generate significant heat. It is recommended to maintain a head temperature below 105°C. With intermittent operation no cooling should be required; however, if the pump is operated continuously cooling may be necessary.

Accessories Information

A **Filter-Muffler** is always recommended in the air inlet or outlet to reduce noise and risk of debris that may affect pump performance. Parker recommends 40 micron or better filtration to be used with this pump series.

6mm Push-In Fittings are recommended to connect the Helix pump pneumatic ports to tubing.



P/N: 00492-15
(10 micron Filter)



P/N: 00085-15-0001
(0.01 micron Filter)



P/N: 20934-15
(6mm to 6mm Legris Connector)

Ordering Information

Configuration	Voltage	Motor Control	Speed at Free Flow 3.0 Vdc Control	Part Number	0	15	30	45	60	75	90
					Free Flow	PSIg	PSIg	PSIg	PSIg	PSIg	PSIg
 H1R Helix Single Head with Unloading Valve	24	0-5 Vdc	2950	H1R-080P24HV-02	5.5	4.3	3.6	2.9	2.2	1.4	0.7

Part Number Description

H 1 R - 080 P 24 H V - 02

Model	Pump Heads	Motor Type	Pump Offset	Configuration	Voltage	Materials	Plumbing	Special
H - Helix	1 - Single Head	R - Outer Rotor BLCD	080 - 0.080" Offset	P - Pressure Only	12 - 12 Vdc	H - PTFE, FKM, EPDM	N - None V - Un-loading Valve	02 - Analog 0-5 Vdc

Accessories Ordering Table

Part No.	Description	Comments
00492-15	Filter-Muffler - 1/8" / 4mm Barbs	Filter to 10 microns
00085-15-0001	Filter-Muffler - Straight 1/4" Port	Filter to 0.01 microns
20934-15	6mm to 6mm Legris Connector	Connects 6mm tubing to Helix pneumatic ports

Ordering Information

Please refer to sizing and selection chart for identifying which one will fit your application

To order on-line go to www.parker.com/precisionfluidics/HelixPump to configure your Helix Pump.

Serviceable – PPF products are designed for use through the rated life and Parker does not sell replacement parts, nor is it recommended to service these in the field

Note: In addition to Parker's innovative and flexible pump designs, we offer applications engineering expertise to our customers in order to configure and recommend the optimal pump for the application. Contact Parker Applications Engineering to discuss and configure alternate pump configurations to meet your specific application requirements. Providing information on the following requirements will assist us in developing an optimal solution for your application:

- Noise
- Operating Pressure / Vacuum
- Power Consumption
- Life Requirement
- Size
- Motor Control
- Media
- Voltage

Parker Hannifin Precision Fluidics Division reserves the right to make changes. Drawings are for reference only.

Appendix A

All performance data is typical based on standard conditions: 70°F and 14.7 psia (21°C and 1 bar).

1. Noise is dependent on the configuration and operation of the pump in the application. Parker has the ability to tailor the pump configuration when noise is a critical criterion in the effort to meet the performance requirements of the application. Noise level is tested to Parker protocol P-105.
2. Life rating can vary depending on application and operating conditions.
3. Custom motor options available. Custom motors may require a significant application potential. The standard motors can be configured with a special winding to meet a particular operation point at a specified voltage
4. Maximum intermittent pressure/vacuum data is a pump capability guideline for applications that go beyond the maximum continuous levels for short periods of time. Please consult customer specific requirements with the factory or Applications Engineering.

Learn More at: discover.parker.com/HelixPump

Below are some common specifications that are helpful to have on hand to accelerate your product selection:

- Gas Type
- Maximum Flow Rate
- Inlet and Outlet Pressures
- Operating Temperature
- Standard Reference Conditions
- Process Connection Size and Type
- Set Point Signal
- Digital Communication Protocol Preferences

For more information call +1 603 595 1500 or email ppfinfo@parker.com

Visit www.parker.com/precisionfluidics

Recommendations on application design and material selection are based on available technical data and are offered as suggestions only. Each user should conduct their own tests to determine the suitability for their own use. Parker offers no express or implied warranties concerning the form, fit, or function of a product in any application.

